

Non pathogenic application protection.
Against external contaminants and sample cross contamination.

- Samples preparation before thermocycling
- Post PCR DNA sequencing revelation / separation
- In Vitro fecondations

- Cellular cultures
- Vegetal Biology
- Sterile solutions preparations

Technical specifications

Dimensions (mm)						
Ref.	External dimensions			Internal dimensions		
	Width	Depth	Height	Width	Depth	Height
391	1030	630	945 mini 1025 maxi	970	555	595

Structure	
Metallic parts	Anti-corrosion steel coated with 100% polyester
Side and front panels	Synthetic glass Thickness adapted for the user protection against rays (Bêta), 32P, Phosphorus: 10mm
Ventilation module	Injected polypropylene

Specifications	
Number of fans (IP44)	1
Processed Air Flow	240 m ³ /h
Number of HEPA H14 filter	1
Number of optional molecular carbon filters	1
Number of UV lamp	2
Number Compact tubular fluorescent lighting	1
Voltage / Frequency	230 V / 50-60Hz
Total power consumption max including electricity for the lights	75 W
Amperage absorbed	0,32 A

Filtration column	
<p>Type IP HEPA H14 FILTER</p> <p>This filtration technology traps particles larger than 0.1 µm with 99.995% efficiency, according to the MPPS method set forth in the EN 1822-1 standard.</p>	
<p>Type IPIC : HEPA H14 Filter + molecular filter</p> <p>Adding a carbon filter to your vented cabinet allows you to protect its volume from gaseous pollutants present in your laboratory environment</p>	

Equipment

Standard Equipment	
Bactericidal UV Lamps:	15W - Wavelength: 254 nm
UV cut-off	Automatic shut off of the UV lamp when the front shield is opened
U.V. Timer	UV timer set up : from 1 to 30 minutes
Flow monitor	Permanent ventilation control device
Energy ports	For the passage of cables
Internal lighting	Compact tubular fluorescent lighting - 18Watts - 500 Lux - IP 67

Standard Equipment	
Work surface in stainless steel	Work surface in stainless steel 304 L with built-in retention tray
Tempered glass Work surface	Tempered glass work surface with sealed frame
Particular Pre-filter	Protect HEPA and molecular filters from dust contained into the laboratory environment

Optional Equipment	
Mobicap	Rolling cart made of anti-corrosion metallic alloy
Benchcap	Fixed work bench made of anti-corrosion metallic alloy
Shelf	Adjustable sliding shelf for Mobicap and Benchcap
Molecular filter	Carbon filter for the adsorption of ambient air VOCs (AS-BE+-F-K types, see our current pricelist)

Compliance to standards

- Air quality within the enclosure: ISO 5*
- *When used in a cleanroom in compliance with ISO 9 / EN 14-644 standard.
- CE Marking

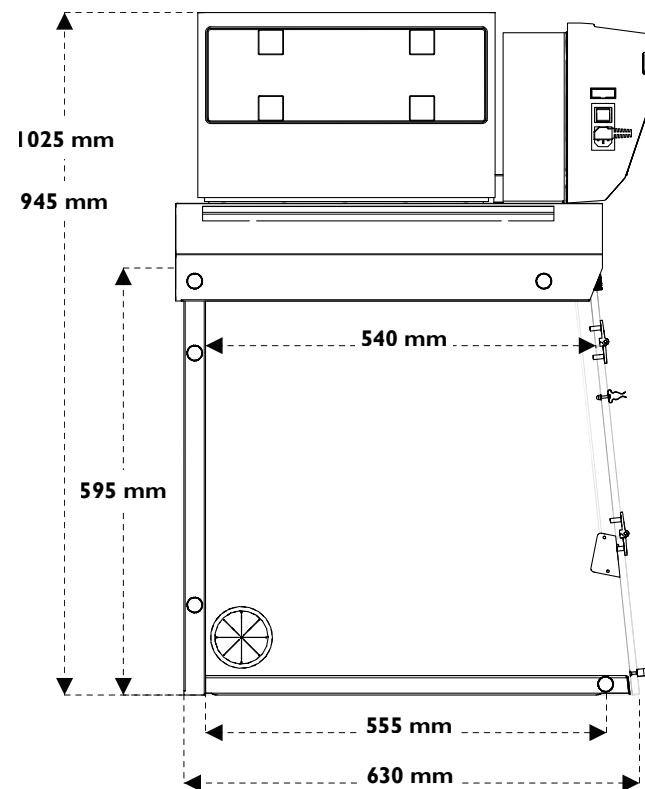
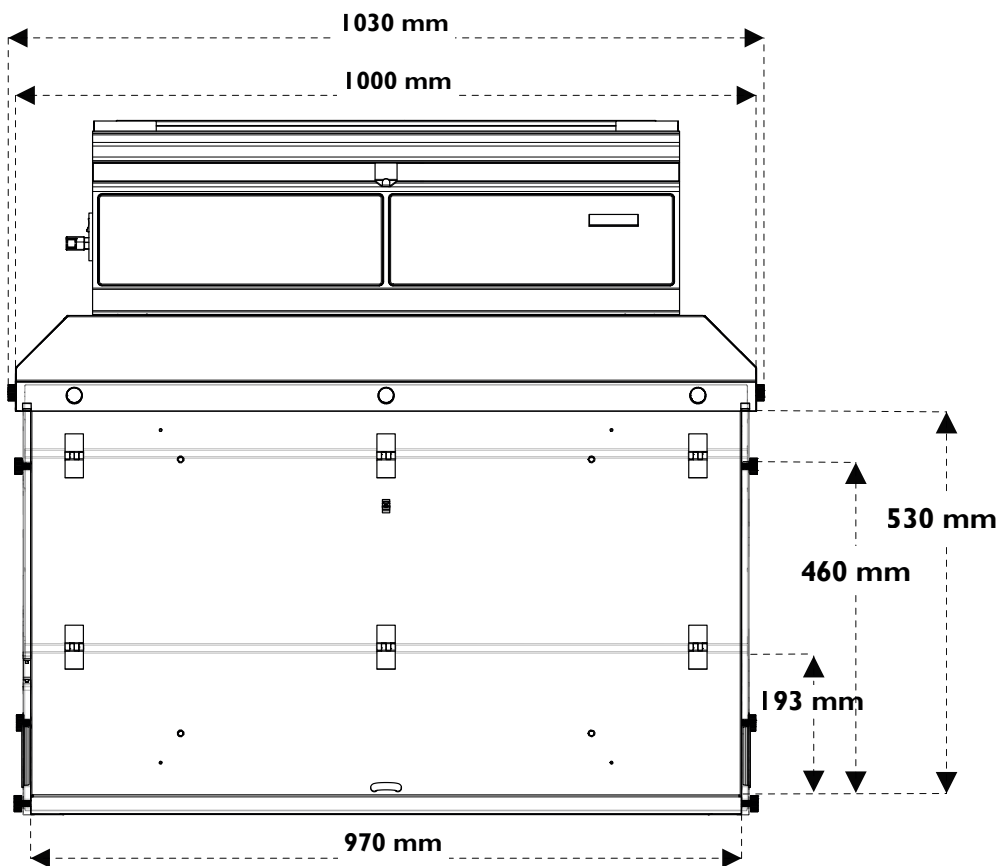
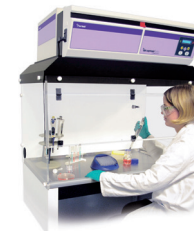



Work surface in stainless steel
304 L with built-in retention tray

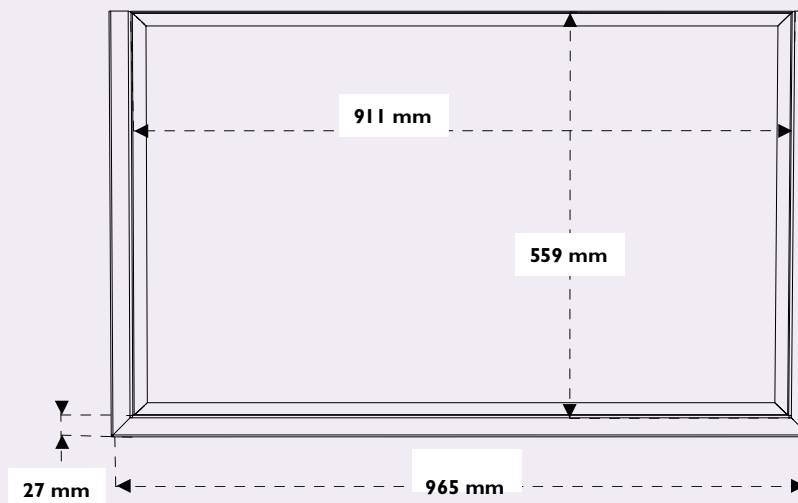

Tempered glass work surface
with sealed frame

